

AQUAGEM®

# INVERTER POOL PUMP

INSTALLATION AND OPERATION MANUAL



# CONTENTS

1. ⚠ IMPORTANT SAFETY INSTRUCTIONS .....	1
2. TECHNICAL SPECIFICATIONS .....	2
3. OVERALL DIMENSION (mm) .....	2
4. INSTALLATION .....	3
5. SETTING AND OPERATION .....	5
6. WIFI OPERATION .....	14
7. EXTERNAL CONTROL .....	22
8. PROTECTION AND FAILURE .....	23
9. MAINTENANCE .....	26
10. WARRANTY & EXCLUSIONS .....	26
11. DISPOSAL .....	27

## 1. IMPORTANT SAFETY INSTRUCTIONS

This guide provides installation and operation instructions for this pump. If you have any other questions about this equipment, please consult your supplier.

**1.1 When installing and using this electrical equipment, basic safety precautions should always be followed, including the following:**

- RISK OF ELECTRICAL SHOCK. Connect only to a branch circuit protected by a ground-fault circuit interrupter (GFCI). Contact a professionally trained and qualified electrician if you cannot verify that the circuit is protected by a GFCI.
- TO PREVENT THE ELECTRICAL SHOCK RISK, please connect the ground wire on the motor (green/yellow) to the grounding system.
- This pump is for use with permanently installed in-ground or above-ground swimming pools and may also be used with hot tubs and spas with a water temperature under 50°C. Due to the fixed installation method, this pump is not suggested to be used on above-ground pools that can be readily disassembled for storage.
- The pump is not submersible.
- Never open the inside of the drive motor enclosure.

**1.2 All installations must be fitted with earth leakage or residual current protection devices, having a rated residual operating current not exceeding 30mA.**

### WARNING:

- Fill the pump with water before starting. Do not run the pump dry. In case of dry run, mechanical seal will be damaged and the pump will start leaking.
- Before servicing the pump, switch power OFF to the pump by disconnecting the main circuit to the pump and release all pressure from pump and piping system.
- Never tighten or loosen screws while the pump is operating.
- Ensure that the inlet and outlet of the pump are unblocked with foreign matter.

## 2. TECHNICAL SPECIFICATIONS

Model	P1	Voltage (V/Hz)	Qmax (m <sup>3</sup> /h)	Hmax (m)	Circulation (m <sup>3</sup> /h)	
	KW				At 10m	At 8m
IM20	0.80	220-240/ 50/60	25.0	18.0	15.5	19.5
IM25	1.10		28.0	20.0	21.5	25.0
IM30	1.40		30.0	21.0	26.7	29.7

## 3. OVERALL DIMENSION (mm)

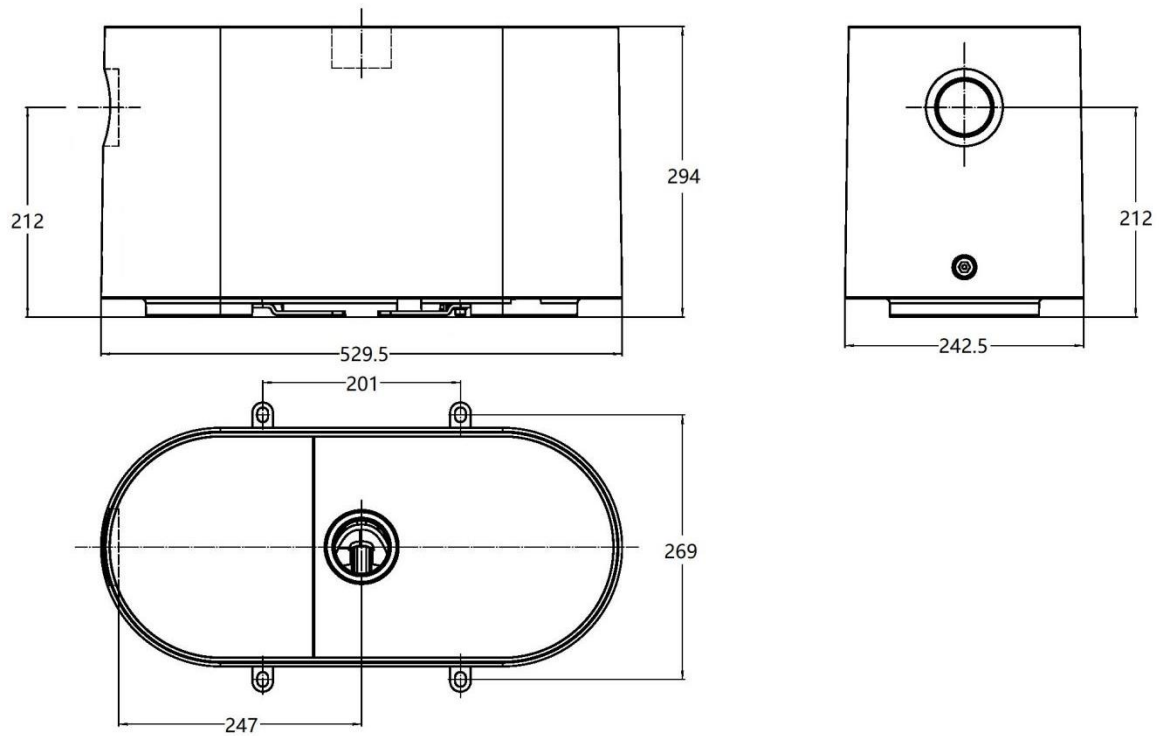

Figure 1

## **4. INSTALLATION**

### **4.1. Pump Location**

- 1) Install the pump as close to the pool as possible, to reduce friction loss and improve efficiency, use short, direct suction and return piping.
- 2) To avoid direct sunshine, heat or rain, it is recommended to place the pump indoors or in the shade.
- 3) DO NOT install the pump in a damp or non-ventilated location. Keep pump and motor at least 150mm away from obstacles, pump motors require free circulation of air for cooling.
- 4) The pump should be installed horizontally and fixed in the hole on the support with screws to prevent unnecessary noise and vibration.

### **4.2. Piping**

- 1) For optimization of the pool plumbing, it is recommended to use a pipe with size of 63mm. When installing the inlet and outlet fittings (joints), use the special sealant for PVC material.
- 2) The dimension of suction line should be the same or larger than the inlet line diameter, to avoid pump sucking air, which will affect the pump's efficiency.
- 3) Plumbing on the suction side of the pump should be as short as possible.
- 4) For most installations we recommend installing a valve on both the pump suction and return lines, which is more convenient for routine maintenance. However, we also recommend that a valve, elbow, or tee installed on the suction line should be no closer to the front of the pump than seven times the suction line diameter.
- 5) Pump outlet piping system should be equipped with a check valve to prevent the pump from the impact of medium recirculation and pump-stopping water hammer.

### 4.3. Valves and Fittings

- 1) Elbows should be no closer than 350mm to the inlet. Do not install 90° elbows directly into the pump inlet/outlet. Joints must be tight.

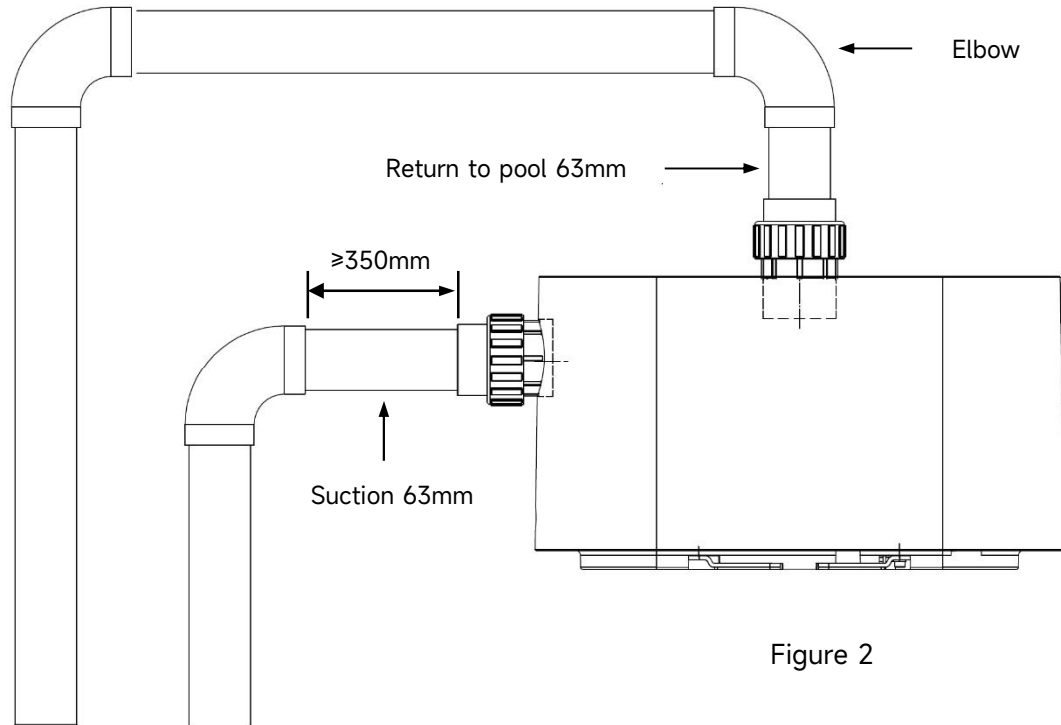

Figure 2

\* The pump inlet/outlet union size: optional with 48.5/50/60.3/63mm

- 2) Flooded suction systems should have gate valves installed on suction and return line for maintenance; however, the suction gate valve should be no closer than seven times the suction pipe diameter as described in this section.
- 3) Use a check valve in the return line where there is a significant height between the return line and the outlet of the pump.
- 4) Be sure to install check valves when plumbing in parallel with other pumps. This helps prevent reverse rotation of the impeller and motor.

### 4.4 Check before initial startup

- 1) Check whether pump shaft rotates freely;
- 2) Check whether power supply voltage and frequency conform to the nameplate;
- 3) It is forbidden to run the pump without water.

#### 4.5 Application conditions

Ambient temperature	Indoor installation, temperature range: -10 - 42°C
Water temperature	5°C-50°C
Salt pools	Salt concentration up to 0.5%, i.e 5g/l
Humidity	≤90% RH, (20°C±2°C)
Installation	The pump can be installed max. 2m above water level;
Protection	Class F, IP55

### 5. SETTING AND OPERATION



#### 5.1 Display on control panel:

	① Power consumption
	② Flow rate
	③ Running capacity
	④ WIFI indicator
	⑤ Unit of flow
	⑥ Timer period
	⑦ Timer 1/2/3/4
	Backwash/unlock
	Up/down: to change the value (capacity/flow/time)
	Switch between Manual Inverter Mode and Auto Inverter Mode. <b>Manual Inverter Mode:</b> The running capacity will be set manually between 30%-120%. <b>Auto Inverter Mode:</b> The running capacity will be automatically adjusted between 30%-120% according to the preset flow rate. The default mode is <b>Manual Inverter</b> mode.
Timer setting	
On/off	

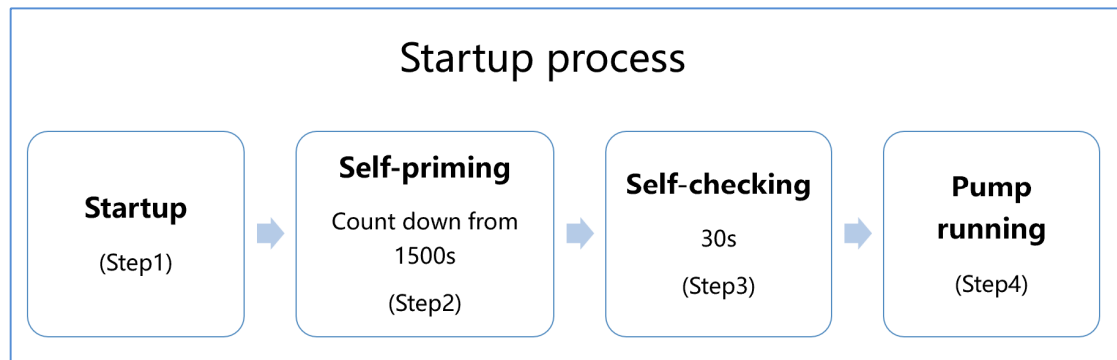
## 5.2 Startup process overview:



### ① Step1: Startup

- Press and hold  for more than 3 seconds to unlock the screen.
- Press  to startup the pump.

### ② Step2: Self-priming

- The pump will start counting down from 1500s; When the system detects the pump is full of water, it will stop counting down and exit priming automatically.
- Users can exit self-priming manually by pressing  for more than 3 seconds. But it's recommended that users should make sure the pump is full of water before exiting self-priming process;
- Users can enter the parameter setting to disable the default self-priming function (see 5.11).

### ③ Step3: Self-checking



- The pump will recheck for 30s again to make sure the self-priming (Step2) is completed.

### ④ Step4: Pump running

- The pump will run at 80% of the running capacity at the initial startup after the self-priming



### 5.3 Startup:

When the power is switched on, the screen will fully light up for 3 seconds, the device code will be displayed, and then it will enter the normal working state. When the screen is locked, only the button  will light up; Press and hold  for more than 3 seconds to unlock the screen. The screen will automatically lock up when there is no operation for more than 1 minute and the brightness of the screen will be reduced to 1/3 of the normal display. Short press  to wake up the screen and observe the relevant operating parameters.



### 5.4 Self-priming

Each time the pump is started, it will start self-priming.

When the pump performs self-priming, it will start counting down from 1500s and stop counting down automatically when the system detects the pump is full of water, then the system will recheck for 30s again to make sure the self-priming is completed.



Users can exit self-priming manually by pressing  for more than 3 seconds. The pump will enter the default Manual Inverter mode at the initial startup.

#### Remark:

- 1) The pump is delivered with self-priming enabled. Each time the pump restarts, it will perform self-priming automatically. Users can enter the parameter setting to disable the default self-priming function (see 5.11)
- 2) If the default self-priming function is disabled, and the pump has not been used for a long time, the water level in the strainer basket may drop. Users can manually activate the self-priming function by pressing both   for 3 seconds, the adjustable period is from 600s to 1500s (default value is 600s).
- 3) After the manual self-priming is completed, the pump will return to the previous state before activating the manual self-priming.
- 4) Users can press  for more than 3 seconds to exit the manual self-priming.

## 5.5 Backwash











Users can start the backwash or fast re-circulation in any running state by pressing .

	Default	Setting range
Time	180s	Press  or  to adjust from 0 to 1500s with 30 seconds for each step
Running capacity	100%	60-100%, enter the parameter setting (see 5.11)

### Exit backwash:

When backwash mode is on, users can hold  for 3 seconds to exit, the pump will return to the previous state before backwash.

## 5.6 Manual Inverter Mode













1		Hold  for more than 3 seconds to unlock the screen.
2		Press  to start. The pump will run at 80% of the running capacity at the initial startup after the self-priming.
3	 	Press  or  to set the running capacity between 30%-120%, each step by 5%.
4		Press  again to switch to Auto Inverter mode.

### Note:

- 1) When the pipeline pressure is too high, to maintain an adequate flow rate, users can set the running capacity to 105%-120%. The pump will run at a higher speed but will not exceed the rated power of each model.
- 2) If the pump has reached the rated power at 105% and the users continues to increase the running capacity, the display will return to 105% when the motor speed is stabilized.

## 5.7 Auto Inverter Mode

Under Auto Inverter Mode, the pump can automatically detect the system pressure and adjust the speed of motor to reach the set flow.











1		Unlock the screen, press  to switch from the Manual Inverter mode to Auto Inverter mode.
2	 	The flow rate could be adjusted, by pressing  or  with 1m <sup>3</sup> /h for each step.
3	 	The unit of flow rate could be changed to LPM or GPM, by pressing both   for 3 seconds.
4		Press  to switch to Manual Inverter mode.

The default adjustable flow range for InverMaster is as below:

Model	Default adjustable flow rate range
IM20	8-25 m <sup>3</sup> /h
IM25	8-28 m <sup>3</sup> /h
IM30	8-30 m <sup>3</sup> /h

## 5.8 Timer mode

The pump's on/off and running capacity could be commanded by a timer, which could be programmed daily as needed.



1	Enter timer setting by pressing 
2	Press  or  to set the local time.
3	Press  to confirm and move to time-1 setting.
4	Press  or  to choose the desired running periods, running capacity or flow rate (when % icon is flashing, users can change to set the flow rate by pressing  ).
5	 Repeat above steps to set the other 3 timers.
6	 Hold 3 seconds to save setting and activate timer mode.
7	 or  Check 4 timers to make sure there is no invalid setting.

**Note:**

1) When timer mode is activated, if the set time period contains the current time, the pump will start running according to the set running capacity or flow rate. If the set time period does not contain the current time, the timer number 

1	2	3	4
---	---	---	---



 (1 or 2 or 3 or 4) that is about to start running will be displayed on the controller and flash, **88:88-88:88** will display the corresponding time period, indicating a successful timer setting.



2) During timer setting, if you want to return to the previous setting, hold both   for 3 seconds. If you don't need to set all 4 timers, you can hold  for 3 seconds, the system will automatically save the current set value and activate the timer mode.

3) Users can exit the timer mode by pressing .

**5.9 Skimmer Mode**

The skimmer mode enables the pump to skim the water surface, prevents the debris from accumulating, and provides users with a cleaner pool.

Hold  and  to enter the preset interface of the skimmer mode. When first switching to this mode, preset 1 will be activated.

Users can press  or  to view the 4 presets, the details of each preset are as below, the selected preset will be activated after 5s without operation.

Preset	Skimmer cycle	Skimmer duration	Skimmer speed/flow	Time period	Remark
1	1h	3 mins	Speed: 100% Flow: 25m <sup>3</sup> /h (IM20) 28m <sup>3</sup> /h (IM25) 30m <sup>3</sup> /h (IM30)	7:00 – 21:00	Editable in parameter setting Press  to switch between skimmer speed and flow
2	1h	10 mins	100%	7:00 – 21:00	Not editable
3	3h	3 mins	80%	7:00 – 21:00	Not editable
4	Turn off the skimmer mode				Not editable

At the skimmer duration, the controller will show the parameter of the preset, users can hold  to exit the skimmer duration each time. When the skimmer duration ends, the pump will return to the normal state for the users to operate.

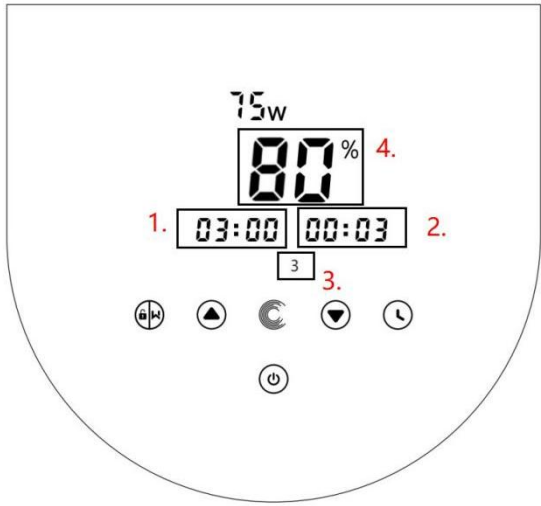
	<ol style="list-style-type: none"> <li>1. Skimmer cycle (hour)</li> <li>2. Skimmer duration (minute)</li> <li>3. Skimmer mode preset number</li> <li>4. Skimmer speed/flow</li> </ol>
---	---

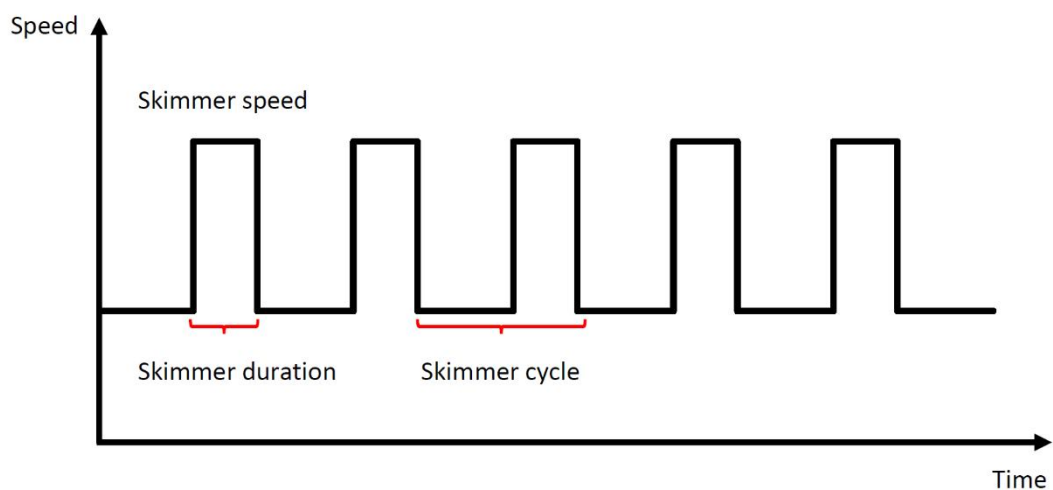

### 5.10 Speed Limit









Users can set the speed limit of the running capacity to meet the flow requirement of other equipment such as sand filters.

Speed limit of the running capacity can be set from 60% - 100% in the parameter setting. (see 5.11) .100% means no speed limit and the running capacity can be set from 30% - 120% under normal operation.



To ensure the performance, the following mode or process will not be limited by the speed limit:

1. Self-priming at each start
2. Manual self-priming
3. Auto Inverter mode
4. Flow rate setting in the timer mode





### 5.11 Parameter Setting

Restore factory setting	Under off mode, hold both   for 3 seconds
Check the software version	Under off mode, hold both   for 3 seconds
Enter parameter setting as below	Under off mode, hold both   for 3 seconds; If current address does not need to be adjusted, hold both   or press  to next address

Parameter Address	Description	Default Setting	Setting Range
1	PIN3	Speed: 100% Flow: 25m <sup>3</sup> /h (IM20) 28m <sup>3</sup> /h (IM25) 30m <sup>3</sup> /h (IM30)	Speed: 30-120%, by 5% increments Flow: 8-25m <sup>3</sup> /h (IM20), 8-28m <sup>3</sup> /h (IM25) 8-30m <sup>3</sup> /h (IM30), by 1 m <sup>3</sup> /h increments  Note: Press  to switch to flow rate setting
2	PIN2	Speed: 80% Flow: 20m <sup>3</sup> /h (IM20) 22m <sup>3</sup> /h (IM25) 24m <sup>3</sup> /h (IM30)	
3	PIN1	Speed: 40% Flow: 10m <sup>3</sup> /h (IM20) 11m <sup>3</sup> /h (IM25) 12m <sup>3</sup> /h (IM30)	
4	Backwash	Speed: 100% Flow: 25m <sup>3</sup> /h (IM20) 28m <sup>3</sup> /h (IM25) 30m <sup>3</sup> /h (IM30)	

5	Control mode of Analog Input	0	0: Current control 1: Voltage control
6	Enable or disable the self-priming at each start	25	25: enables 0: disables
7	Reserved	0	Not editable
8	System time	00:00	00:00 - 23:59
9	Preset 1 of the skimmer mode (skimmer cycle, skimmer duration, skimmer speed/flow)	01:00 00:03 100%	Skimmer cycle: 1-24h, 1h for each step Skimmer duration: 1-30min, 1min for each step Skimmer speed: 30%-100%, by 5% increments Skimmer flow: 8-25m <sup>3</sup> /h (IM20), 8-28m <sup>3</sup> /h (IM25), 8-30m <sup>3</sup> /h (IM30), by 1 m <sup>3</sup> /h increments Note: Press  to switch to flow rate setting
10	Time period of the preset 1 of the skimmer mode	7:00-21:00	Start time: 00:00-24:00 End time: 00:00-24:00
11	Speed limit	Speed: 100% Flow: 28m <sup>3</sup> /h	Speed: 60%-100%, by 5% increments (100% means no speed limit) Flow: 15-25 m <sup>3</sup> /h (IM20), 17-28m <sup>3</sup> /h (IM25), 18-30 m <sup>3</sup> /h (IM30), by 1 m <sup>3</sup> /h increments Note: Press  to switch to flow rate setting
12	RS485 address	170(0xAA)	160-190 (0xA0-0xBF), each step by 1.
13	Reserved	0	Not editable

### For example: How to Enable/Disable Self-Priming Function?

- 1) **Enter parameter setting:** Under off mode, hold both   for 3 seconds;
- 2) **Select parameter address:** Press  to address 6;
- 3) **Enable or disable the self-priming at each start:** Adjust by pressing  or ,  
25= Enables, 0=Disables.

## 6. WIFI OPERATION

### ① Download InverFlow APP



Android



iOS



### ② Account Registration

Register by e-mail or third-party application.

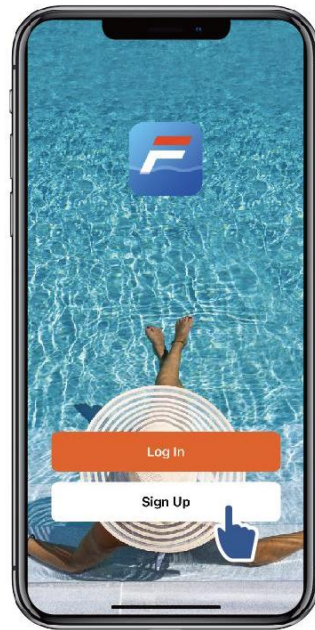

#### a. Email Registration

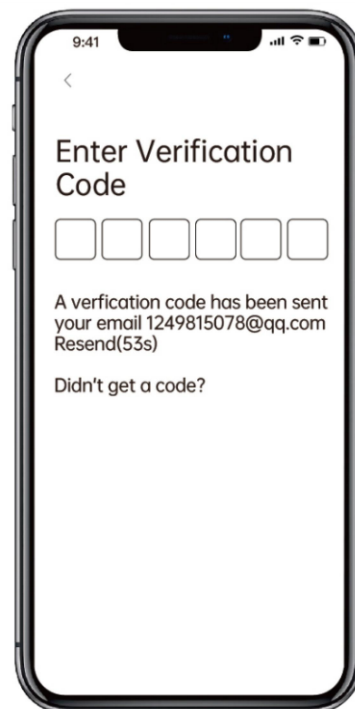
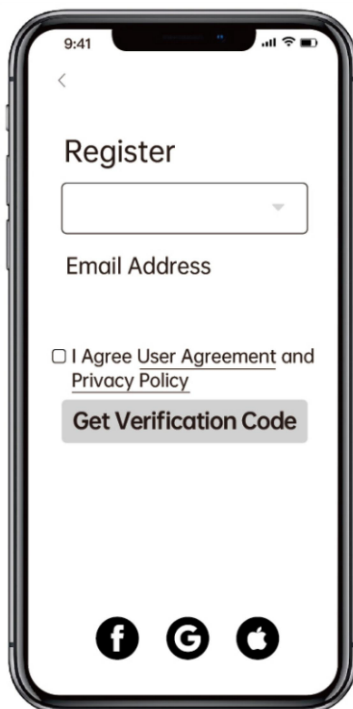



b. Third-party application registration

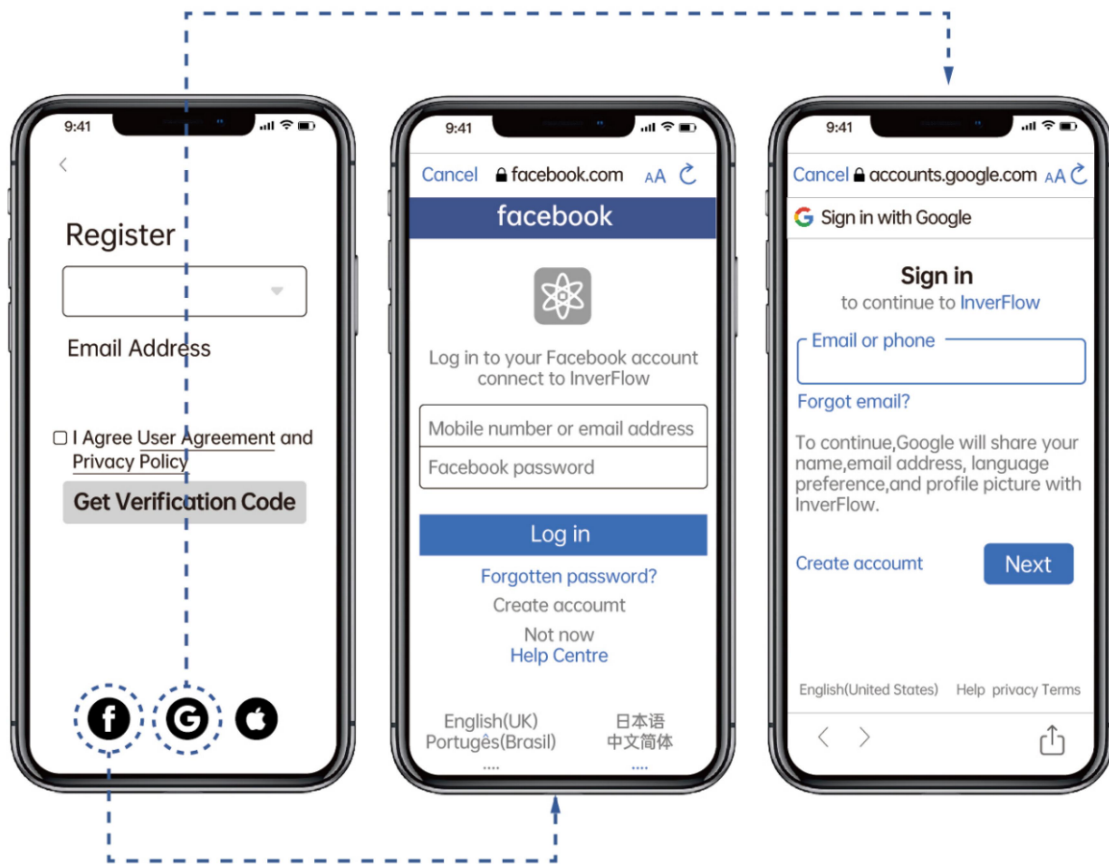

### 3 Create Home

Please set home name and choose the location of the device. (It is recommended to set the location so the weather can be shown in the App for your convenience)

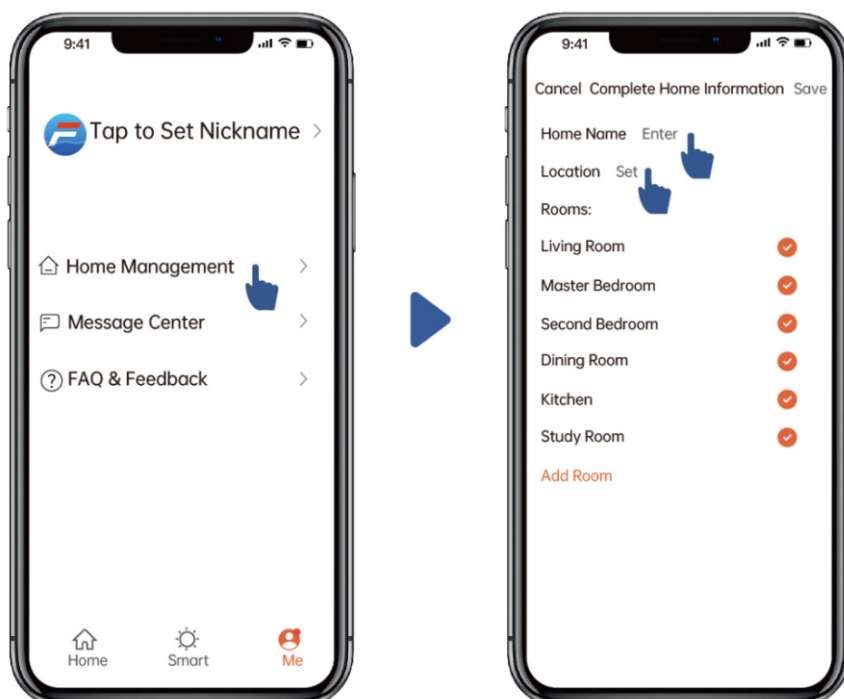

## 4 App pairing

Please make sure your pump is turned on before you start.

### Option 1 (Recommended): With Wifi and Bluetooth

(Network requirement: 2.4GHz; 2.4GHz and 5GHz into one SSID; but no separate 5GHz network)

1) Please confirm that your phone is connected to Wifi and your Bluetooth is on.

2) Press  for 3 seconds until hearing “Beep” to unlock the screen. Press  for 5

seconds until hearing “Beep” and then release.  will flash.

3) Click “Add Device”, and then follow the instructions to pair device.

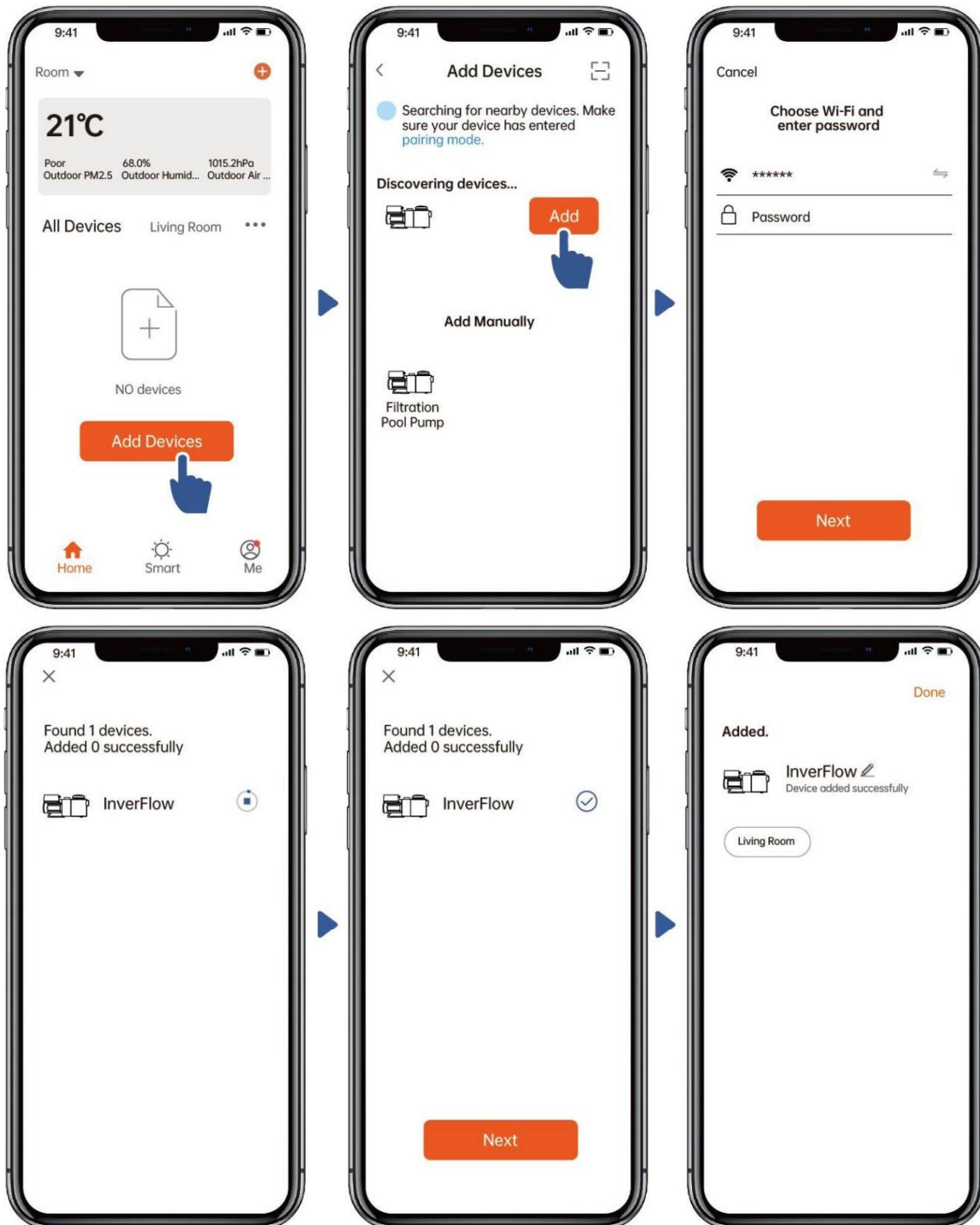

## Option 2: With Wifi (Network requirement: 2.4GHz only)

1) Please confirm that your phone is connected to Wifi

2) Press  for 3 seconds until hearing “Beep” to unlock the screen. Press  for 5

seconds until hearing “Beep” and then release.  will flash.

3) Click “Add Device”, and then follow the instructions to pair device.

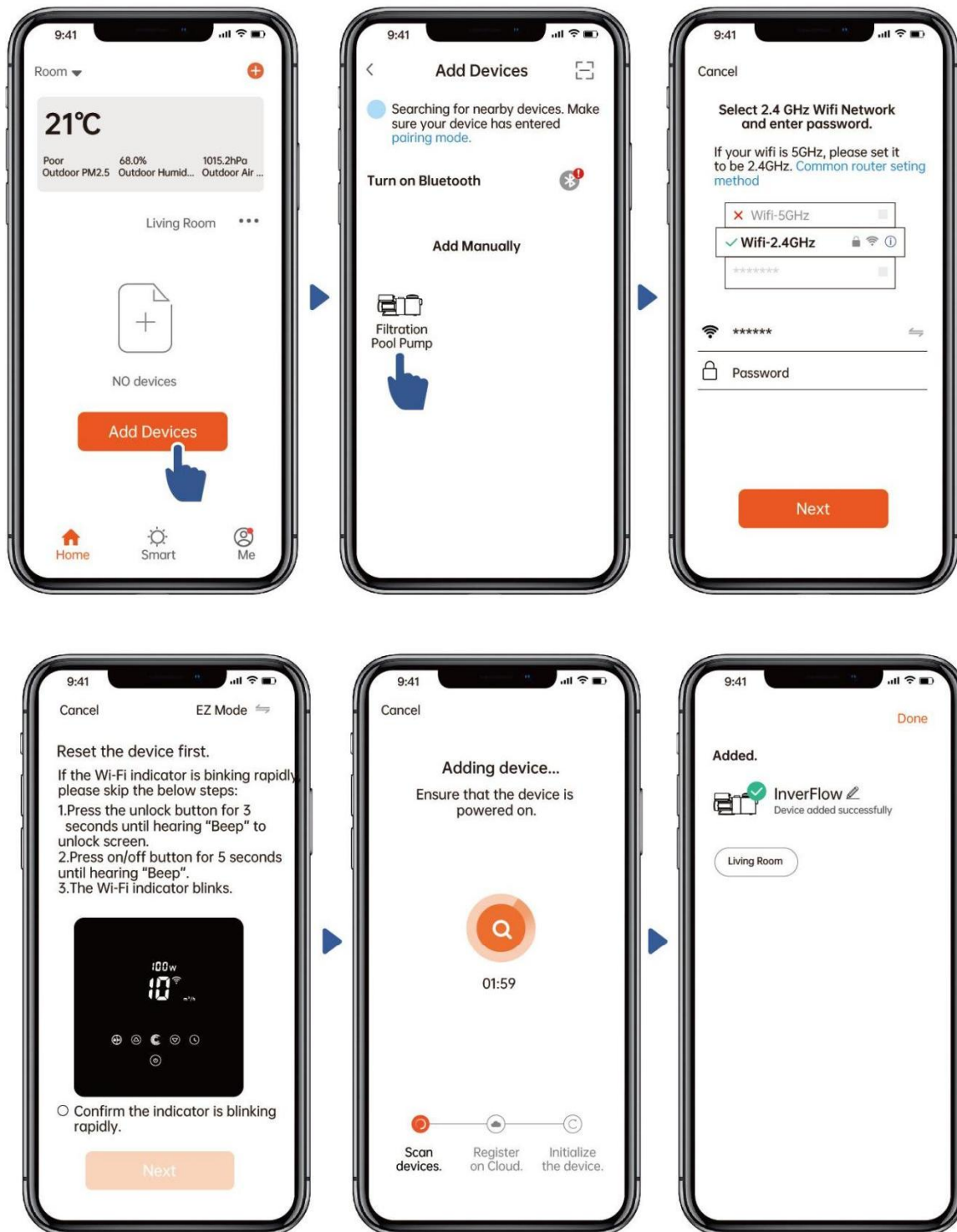

## 5 Operation

1) Using Auto Inverter mode:

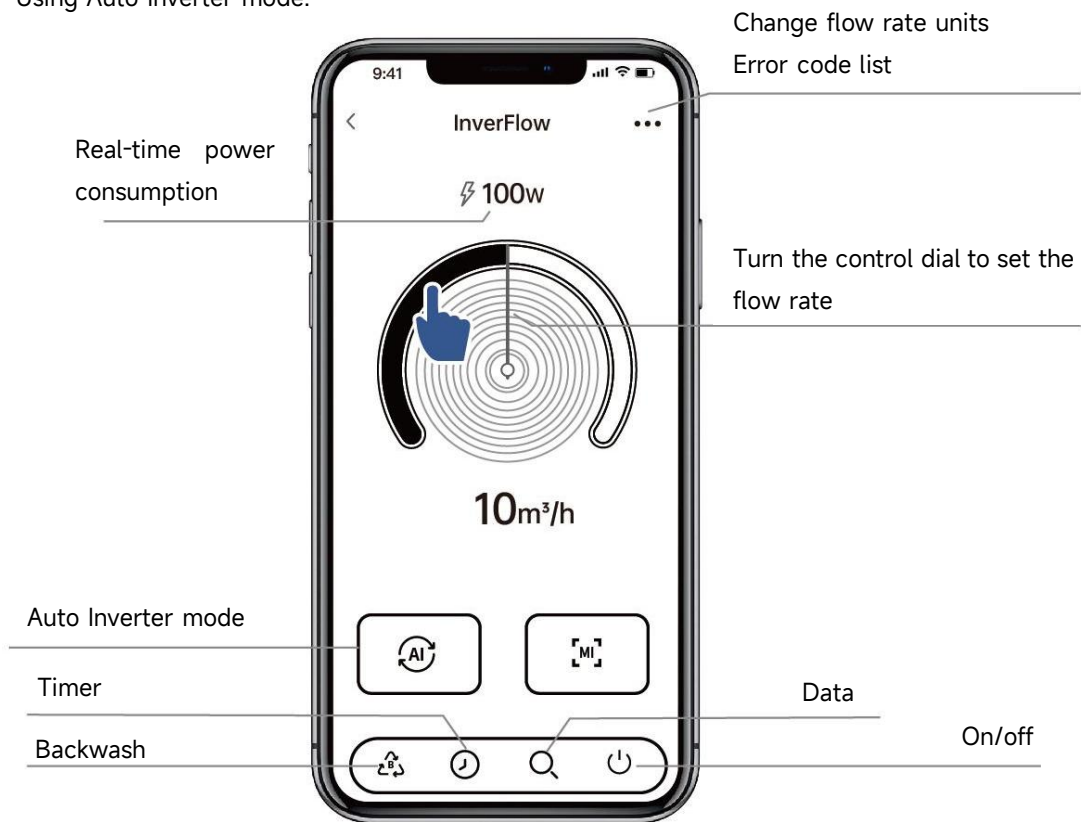

2) Using Manual Inverter mode:

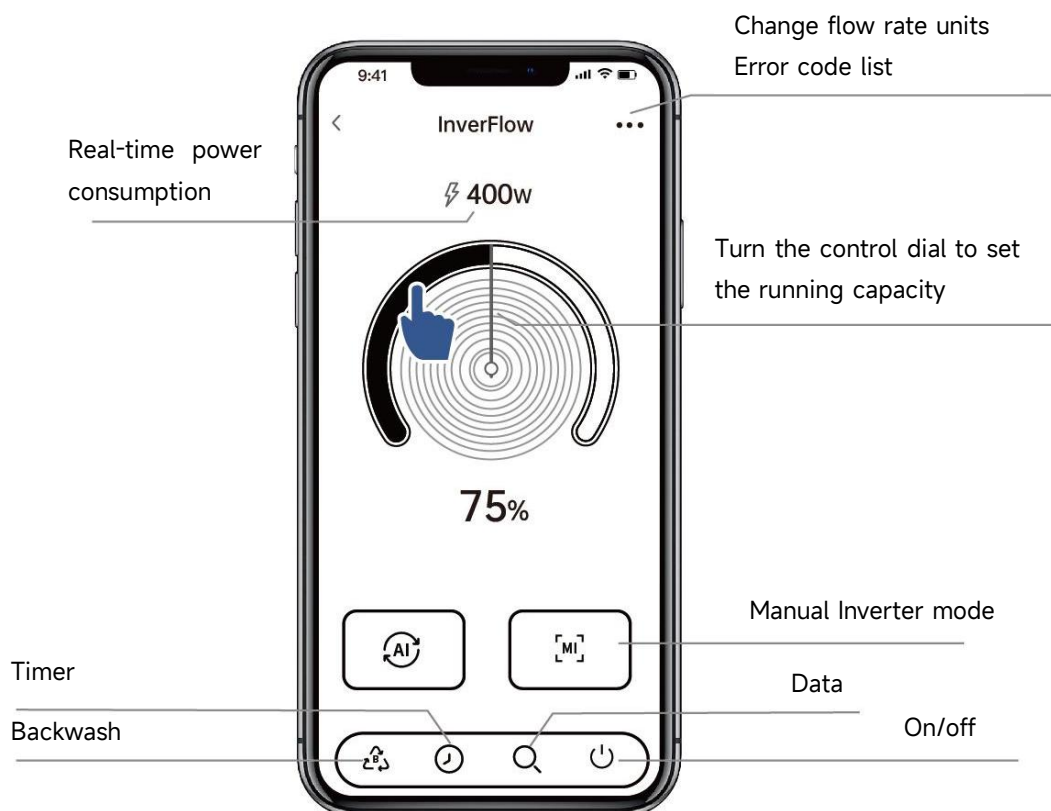

**Notice for the timer setting via the APP:**

- 1) Time variance is  $\pm 30s$ ;
- 2) In order to avoid overlapping timing points conflicting and invalidating due to network delay, it is recommended that the end time and the start time of the next timing period cannot overlap, and a sufficient time interval should be reserved, for example, at least 2 minutes;

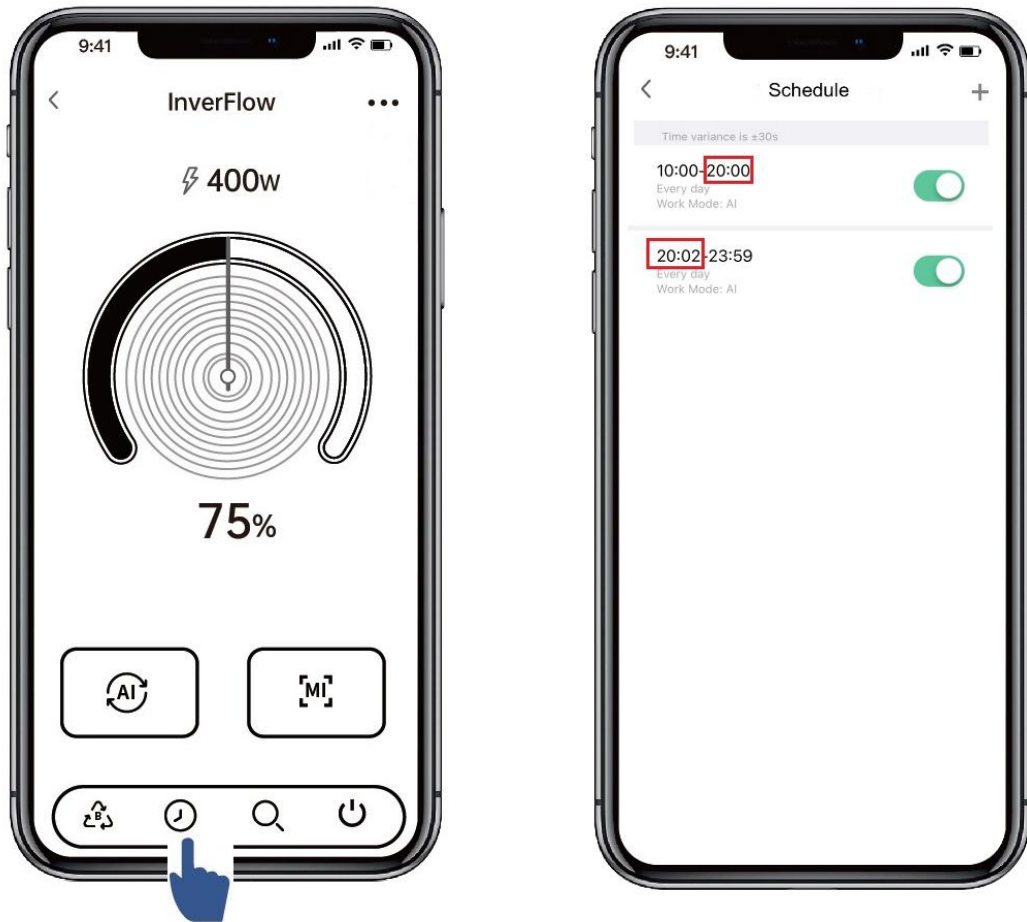

## 6 Sharing Devices with your family members

After pairing, if your family members also want to control the device, please let your family members register “InverFlow” first, and then the administrator can operate as below:

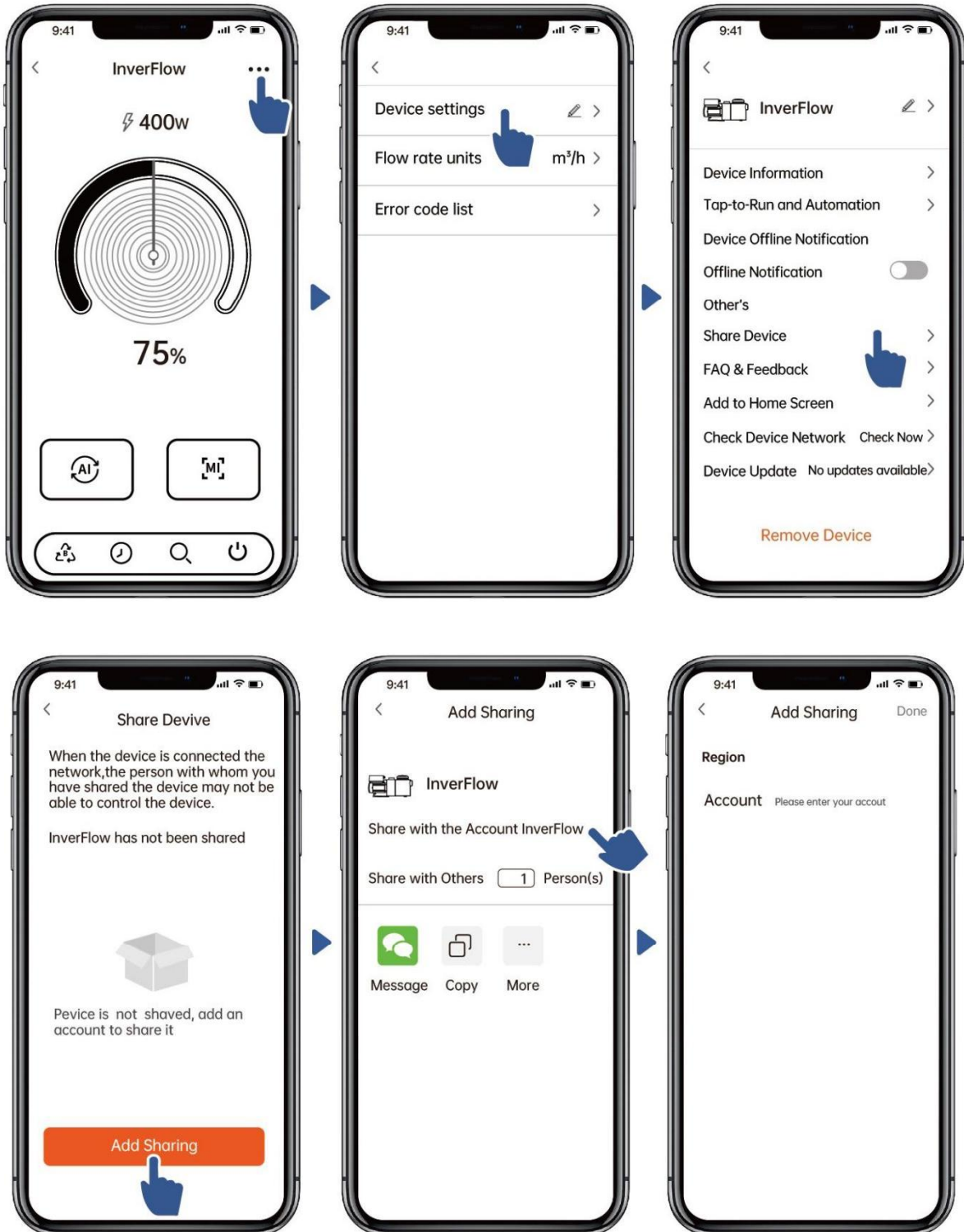

## 7 Feedback

If you have any problem while using, welcome to send feedback.

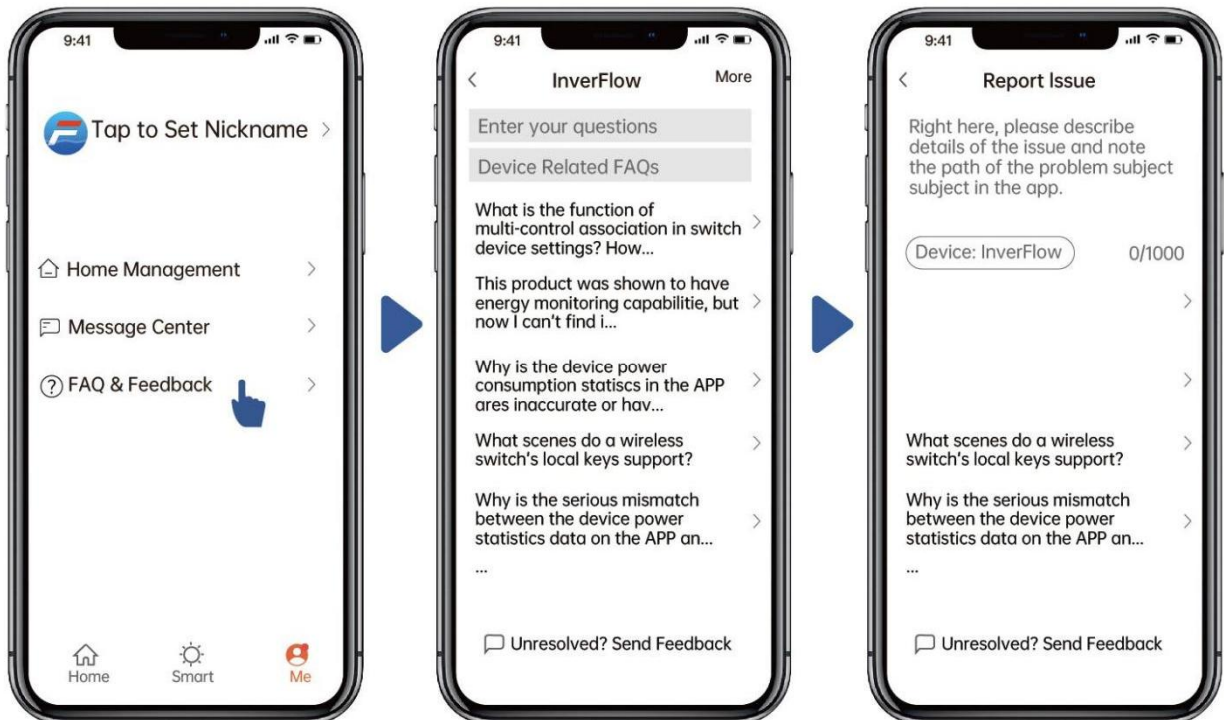

Notice:

- 1) The weather forecast is just for reference;
- 2) The power consumption data is for reference only, as it may be affected by network problems and imprecision of the calculation.
- 3) The App is subject to updates without notice.

## 7. EXTERNAL CONTROL

External control can be enabled via following contacts. If more than one external control is enabled, the priority is as below: Digital Input > RS485 > Panel control

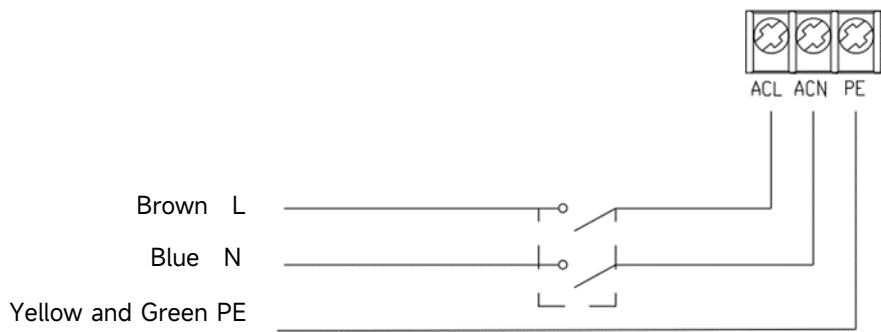
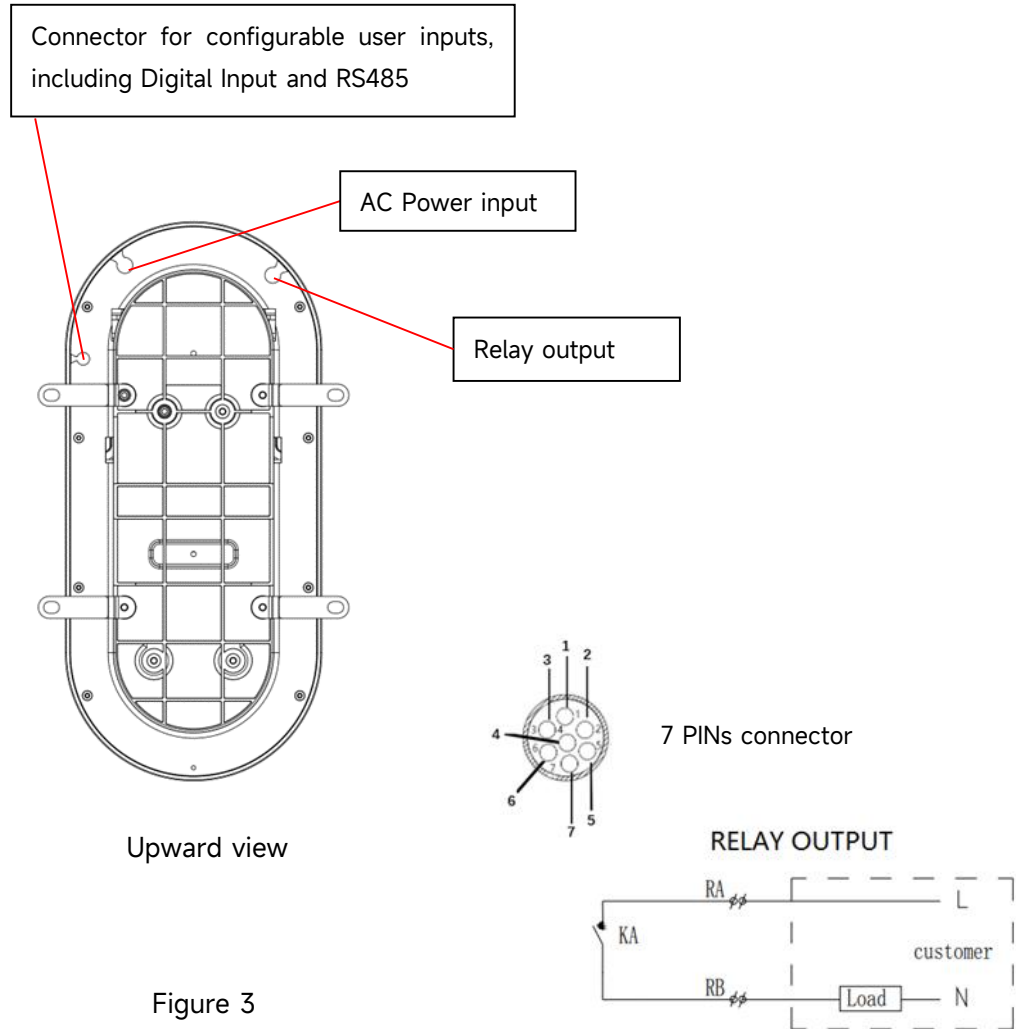



Name	Color	Description
PIN 1	Red	Digital Input 4
PIN 2	Black	Digital Input 3
PIN 3	White	Digital Input 2
PIN 4	Grey	Digital Input 1
PIN 5	Yellow	Digital Ground
PIN 6	Green	RS485 A
PIN 7	Brown	RS485 B

#### a. Digital input

Running capacity is determined by the state of digital input,

- 1) When PIN4 connects with PIN5, the pump will be mandatory to stop; if disconnected, the digital control will be invalid;
- 2) When PIN3 connects with PIN5, the pump will be mandatory to run at 100%; if disconnected, the control priority will be back on panel control;
- 3) When PIN2 connects with PIN5, the pump will be mandatory to run at 80%; if disconnected, the control priority will be back on panel control;
- 4) When PIN1 connects with PIN5, the pump will be mandatory to run at 40%; if disconnected, the control priority will be back on panel control;
- 5) The capacity of inputs (PIN1/PIN2/PIN3) could be modified according to the parameter setting.

#### b. RS485:

To connect with PIN6 and PIN7, the pump could be controlled via Modbus 485 communication protocol.

#### c. Relay output:

Connect terminals L & N with RA & RB cable to enable relay output. An additional on-off Relay is necessary while bearing power is greater than 500W (2.5A).

## 8. PROTECTION AND FAILURE

### 8.1 High-Temperature Warning and Speed Reduction

In "Auto Inverter/Manual Inverter Mode" and "Timer mode" (except backwash/self-priming), when the module temperature reaches the high-temperature warning trigger threshold (81°C), it enters the high temperature warning state; when the temperature drops to the high-temperature warning release threshold (78°C), the high-temperature warning state is released. The display area alternately displays AL01 and running speed or flow.

- a) If AL01 is displayed for the first time, the running capacity will be automatically reduced as below:
  - 1) If current operating capacity is higher than 100%, the running capacity will be automatically reduced to 85%;
  - 2) If current operating capacity is higher than 85%, the running capacity will be automatically

- reduced by 15%;
- 3) If current operating capacity is higher than 70%, the running capacity will be automatically reduced by 10%;
  - 4) If current operating capacity is lower than 70%, the running capacity will be automatically reduced by 5%.
- b) If AL01 is not displayed for the first time, the running capacity will be automatically reduced as below:
- 1) If the module temperature is lower than 85 °C , the controller will detect the module temperature every 2mins , for each 1°C increments in temperature, the running capacity will be automatically reduced by 5%;
  - 2) If the module temperature is higher than 85 °C , the controller will detect the module temperature every 2mins:
    - 2.1) if it detects the module temperature is increased, for each 1°C increments in temperature, the running capacity will be automatically reduced by 5%;
    - 2.2) if it detects the module temperature remains unchanged, the running capacity will be automatically reduced by 5%;

## 8.2 Undervoltage protection

When the device detects that the input voltage is less than 198V, the device will limit the current running speed. The display area alternately displays AL02 and running speed or flow.

- 1) When input voltage is less than or equal to 180V, the running capacity will be limited to 70%;
- 2) When the input voltage range is within 180V - 190V, the running capacity will be limited to 75%;
- 3) When the input voltage range is within 190V - 198V, the running capacity will be limited to 85%.

## 8.3 Troubleshooting

Problem	Possible causes and solution
<b>Pump does not start</b>	<ul style="list-style-type: none"> <li>• Power Supply fault, disconnected or defective wiring.</li> <li>• Fuses blown or thermal overload open.</li> <li>• Check the rotation of the motor shaft for free movement and lack of obstruction.</li> <li>• Because of a long time lying idle. Unplug the power supply and manually rotate motor's rear shaft a few times with a screwdriver.</li> </ul>
<b>Pump does not prime</b>	<ul style="list-style-type: none"> <li>• Empty pump/strainer housing. Make sure the pump/strainer housing is filled with water and the O ring of cover is clean.</li> <li>• Loose connections on the suction side.</li> <li>• Strainer basket or skimmer basket loaded with debris.</li> <li>• Suction side clogged.</li> <li>• Distance between pump inlet and liquid level is higher than 2m, the installation height of pump should be lowered.</li> </ul>
<b>Low Water</b>	<ul style="list-style-type: none"> <li>• Pump does not prime.</li> </ul>

<b>Flow</b>	<ul style="list-style-type: none"> <li>• Air entering suction piping.</li> <li>• Basket full of debris.</li> <li>• Inadequate water level in pool.</li> </ul>
<b>Pump being noisy</b>	<ul style="list-style-type: none"> <li>• Air leak in suction piping, cavitation caused by restricted or undersized suction line or leak at any joint, low water level in pool, and unrestricted discharge return lines.</li> <li>• Vibration caused by improper installation, etc.</li> <li>• Damaged motor bearing or impeller (need to contact the supplier for repair).</li> </ul>

#### 8.4 Error code

When the device detects a failure (except for the running capacity reduction strategy and 485 communication failure), it will stop automatically and display the error code. After stopping for 15 seconds, check if the failure is cleared. If cleared, the pump will resume working.

Item	Error Code	Description
1	E001	Abnormal input voltage
2	E002	Output over current
3	E101	Heat sink overheat
4	E102	Heat sink sensor error
5	E103	Master driver board error
6	E104	Phase-deficient protection
7	E105	AC current sampling circuit failure
8	E106	DC abnormal voltage
9	E107	PFC protection
10	E108	Motor power overload
11	E201	Circuit board error
12	E203	RTC time reading error
13	E204	Display Board EEPROM reading failure
14	E205	Communication Error
15	E207	No water protection
16	E208	Pressure sensor failure
17	E209	Loss of prime

Note:

- 1) When E002/E101/E103 is displayed, the device will resume working automatically.
- 2) When E002/E101/E103 appears a fourth time, the device will stop working, to resume operation, unplug the device and plug in & restart again.

## 9. MAINTENANCE

Empty the strainer basket frequently. The basket should be inspected through the transparent lid and emptied when there is an evident stack of rubbish inside. The following instructions should be followed:

- 1). Disconnected the power supply.
- 2). Press the cover plate to spring it up and open the cover plate. (see Figure 5)

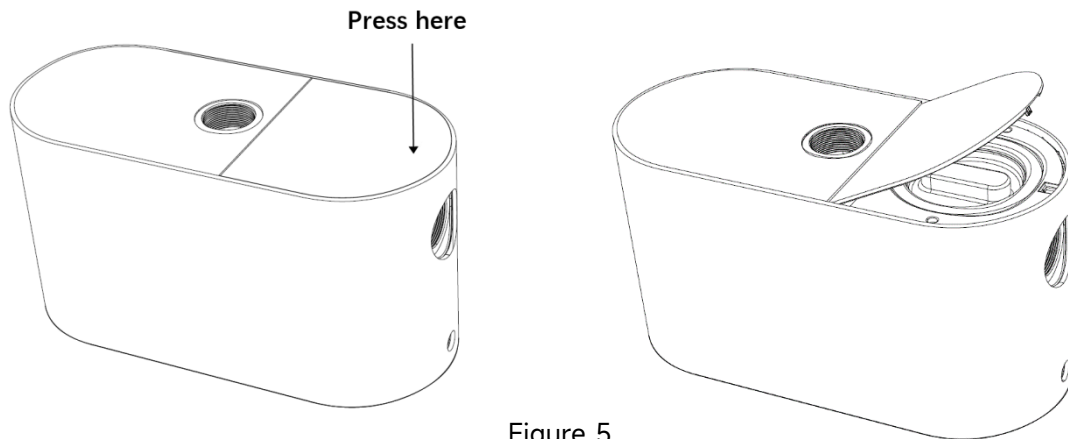

Figure 5

- 3). Unscrew the strainer basket lid anti-clockwise and remove.
- 4). Lift up the strainer basket.
- 5). Empty the trapped refuse from the basket and rinse out the debris if necessary.

**Note: Do not knock the plastic basket on a hard surface as it will cause damage**

- 6). Inspect the basket for signs of damage, and replace it.
- 7). Check the lid O-ring for stretching, tears, cracks or any other damage
- 8). Replace the lid, hand tightening is sufficient.

**Note: Periodically inspecting and cleaning the strainer basket will help prolong its life.**

## 10. WARRANTY & EXCLUSIONS

Should a defect become evident during the term of warranty, at its option, the manufacturer will repair or replace such item or part at its own cost and expense. Customers need to follow the warranty claim procedure in order to obtain the benefit of this warranty.

The guarantee will be void in cases of improper installation, improper operation, inappropriate use, tampering or using of non-original spare parts.

## 11. DISPOSAL



When disposing of the product, please sort the waste products as electrical or electronic product waste or hand it over to the local waste collection system.

The separate collection and recycling of waste equipment at the time of disposal will help ensure that it is recycled in a manner that protects human health and the

environment. Contact your local authority for information on where you can drop off your water pump for recycling

IM1C-18